

AU-001

Network Horn Speaker

Clear Sound • IP66 • PoE+ • HTTPS

- All Metal & Clear Sound
- Dust and Water Tight – IP66
- Powered from the Network Cable Using PoE+
- Remote Configuration and Firmware Upgrade by HTTPS



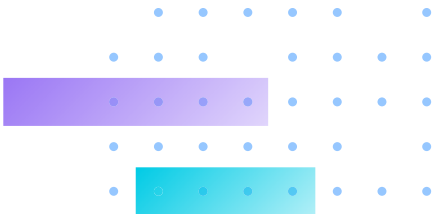

Overview

AU-001 Network Horn Speaker is the outdoor speaker provides long range voice alarm to warn the people who are triggered by any event, for example Smart VCA, DI and etc. It's also compatible with VAST2 for all the functionalities and allow users to upload their own audio clips on VAST 2 for broadcasting.

AU-001 has a high sound with sensitivity 106 dB which can be placed anywhere, enabling a flexible, scalable and cost-effective approach to system design. It is easy to install and be powered up with build in PoE (Power over Ethernet).

Application

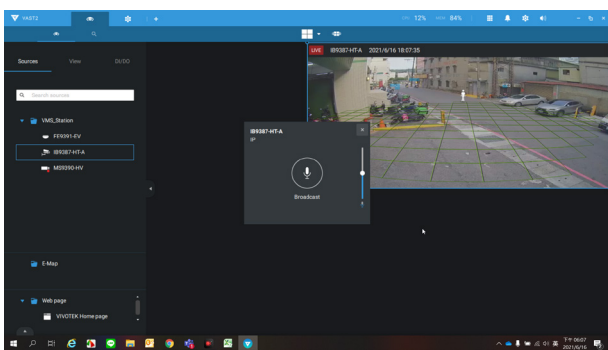
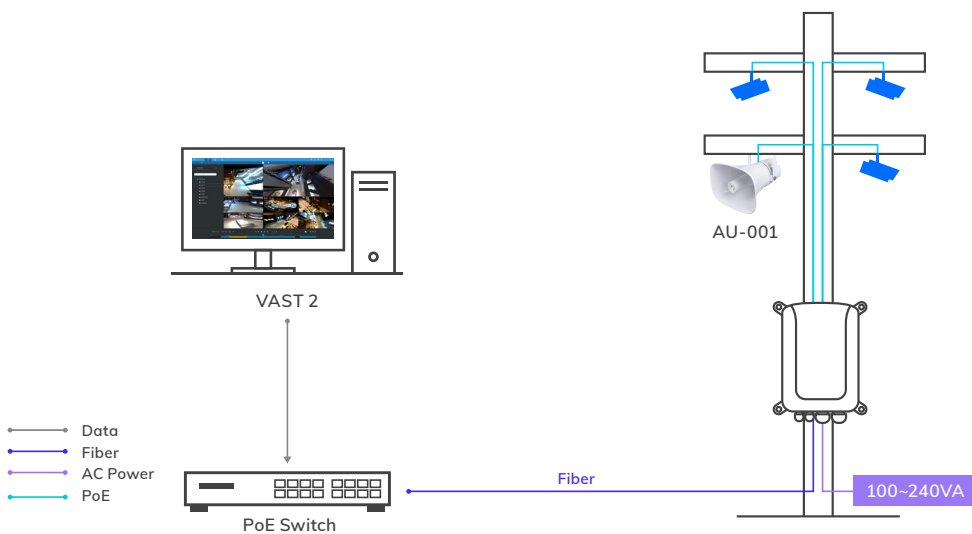

Broadcast via VAST 2

Support Manual Broadcast On VAST 2 Live View

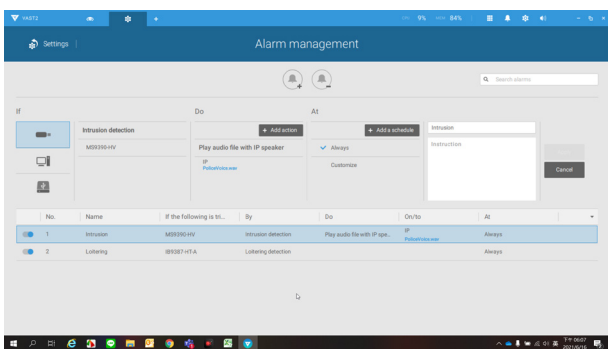

Full Integrate with VAST 2 Alarm Management

Support Broadcast Audio File Automatically when VAST 2 Alarm Management is Triggered

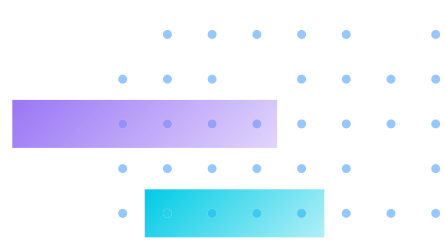

Technical Specifications

Model	AU-001
Specification	
Rated Impedance	8 ohm
Average Min. power	20W
Voice Coil Former	Kapton Bobbin spherical polyimide 16 ohm
Frequency Ranges	330 Hz~ 8000 Hz
Max. SPL 1W / 1M	106 dB
Material	Aluminum cast powder painting
Microphone	100Hz-16KHz Single point, SPL-44 ± 2db AT 2 KΩ
LED Luminous	1x LED display status
Network	
SIP support	RFC 3261(SIP base standard)
Interface	WAN: RJ-45x1, 10/100Mbps Fast Ethernet port
Supported Protocols	SIP, IPv4/v6, RIPv2 / OSPF, HTTPS, QoS DSCP, FTP, TFTP, SNMP v2c / v3, SNMP, IGMP, DHCP, SSHv2, PIM- DVMRP, RMON.
Audio Codec	G.711 a/uLaw, G.726, G.722, G.729, iLBC, L16
Support Function	Auto provision, Audio tone testing, System log
Integration Features on VAST 2 (License Required)	
Two-way Communication	Supported
Automatic Trigger Audio Clips	Supported
General	
Casing	Robust aluminum, IP66 water/dust proof
Power	PoE+ (Power over Ethernet), IEEE 802.3at
Operating Conditions	-35°C ~ 60°C (-31°F ~ 140°F)
Dimensions	280x200x280 mm (11x7x11 inch)
Weight	1.95 kg (4.3lbs)
Safety Certifications	CE, FCC, LVD EN62368-1
Warranty	24 months

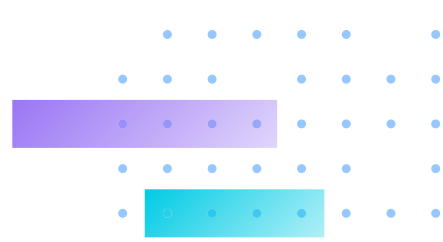

Dimensions

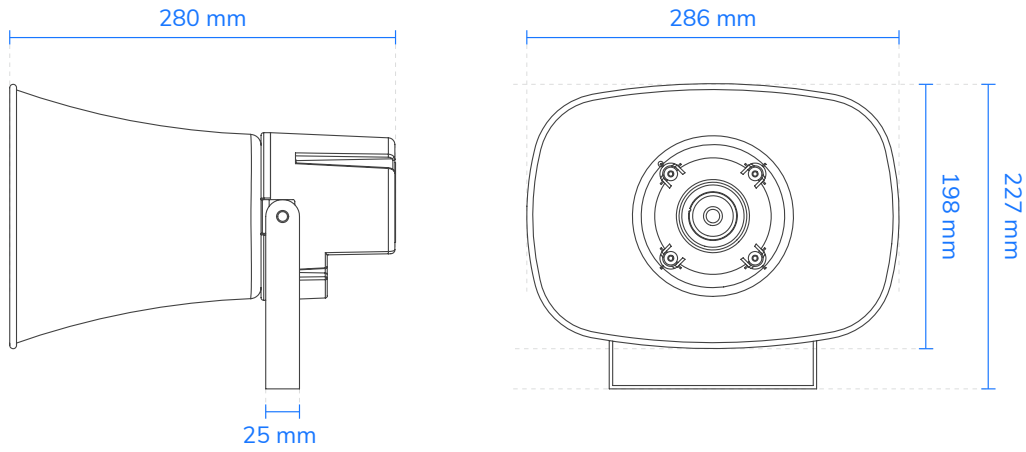

Optional Accessories

Mounting Bracket



AM-314
Pole Mount Bracket

Outdoor Surge Protector



AP-PSP-050
Outdoor Surge Protector